

# Generator Information

## Stamford PE-734-B

- Generator Data Sheet
- Voltage Regulator

### **GENERATOR DATA NOTE:**

- The Generator data supplied by the manufacture is the data of what the generator is capable of producing. When the generator is connected to the Jenbacher engine, it does not produce to the manufacturer's nameplate data.
- The Technical Description contains the data of the generator connected to the engine, Section 0.03 Technical Data of Generator.
- Use the Technical Description generator data for energy calculations.

## Blank Page for Notes

# STAMFORD®

## PI734B - Technical Data Sheet

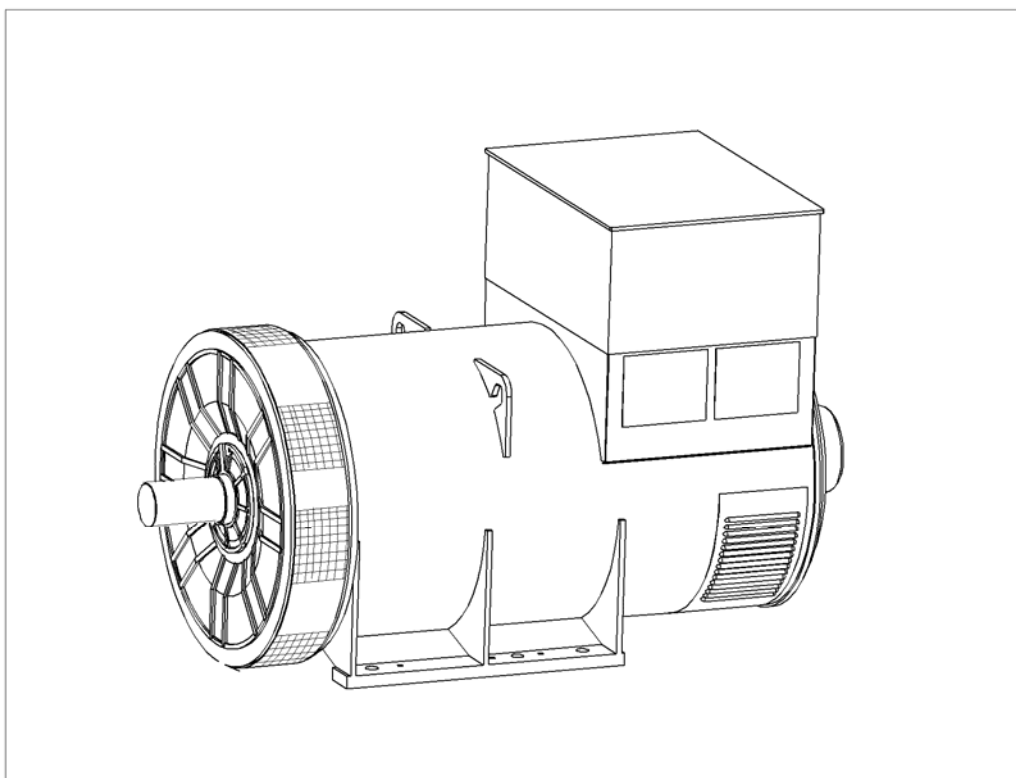

# PI734B

## SPECIFICATIONS & OPTIONS

### STANDARDS

Newage Stamford industrial generators meet the requirements of BS EN 60034 and the relevant sections of other national and international standards such as BS5000, VDE 0530, NEMA MG1-32, IEC60034, CSA C22.2-100, AS1359.

Other standards and certifications can be considered on request.

### DESCRIPTION

The STAMFORD PI range of synchronous ac generators are brushless with a rotating field. They are separately excited by the STAMFORD Permanent Magnet Generator (PMG). This is a shaft mounted, high frequency, pilot exciter which provides a constant supply of clean power via the Automatic Voltage Regulator (AVR) to the main exciter. The main exciter output is fed to the main rotor, through a full wave bridge rectifier, protected by surge suppression.

### VOLTAGE REGULATORS

The PI range generators, complete with a PMG, are available with one of two AVRs. Each AVR has soft start voltage build up and built in protection against sustained over-excitation, which will de-excite the generator after a minimum of 8 seconds.

Underspeed protection (UFRO) is also provided on both AVRs. The UFRO will reduce the generator output voltage proportional to the speed of the generator below a pre-settable level.

The **MX341 AVR** is two phase sensed with a voltage regulation of  $\pm 1\%$ . (see the note on regulation).

The **MX321 AVR** is 3 phase rms sensed with a voltage regulation of 0.5% rms (see the note on regulation). The UFRO circuit has adjustable slope and dwell for controlled recovery from step loads. An over voltage protection circuit will shutdown the output device of the AVR, it can also trip an optional excitation circuit breaker if required. As an option, short circuit current limiting is available with the addition of current transformers.

Both the MX341 and the MX321 need a generator mounted current transformer to provide quadrature droop characteristics for load sharing during parallel operation. Provision is also made for the connection of the STAMFORD power factor controller, for embedded applications, and a remote voltage trimmer.

### WINDINGS & ELECTRICAL PERFORMANCE

All generator stators are wound to 2/3 pitch. This eliminates triplen (3rd, 9th, 15th ...) harmonics on the voltage waveform and is found to be the optimum design for trouble-free supply of non-linear loads. The 2/3 pitch design avoids excessive neutral currents sometimes seen with higher winding pitches. A fully connected damper winding reduces oscillations during paralleling. This winding, with the 2/3 pitch and carefully selected pole and tooth designs, ensures very low levels of voltage waveform distortion.

### TERMINALS & TERMINAL BOX

Standard generators feature a main stator with 6 ends brought out to the terminals, which are mounted on the frame at the non-drive end of the generator. A sheet steel terminal box contains the AVR and provides ample space for the customers' wiring and gland arrangements. It has removable panels for easy access.

### SHAFT & KEYS

All generator rotors are dynamically balanced to better than BS6861:Part 1 Grade 2.5 for minimum vibration in operation. Two bearing generators are balanced with a half key.

### INSULATION/IMPREGNATION

The insulation system is class 'H', and meets the requirements of UL1446.

All wound components are impregnated with materials and processes designed specifically to provide the high build required for static windings and the high mechanical strength required for rotating components.

### QUALITY ASSURANCE

Generators are manufactured using production procedures having a quality assurance level to BS EN ISO 9001.

### NOTE ON REGULATION

The stated voltage regulation may not be maintained in the presence of certain radio transmitted signals. Any change in performance will fall within the limits of Criteria 'B' of EN 61000-6-2:2001. At no time will the steady-state voltage regulation exceed 2%.

Note: Continuous development of our products entitles us to change specification details without notice, therefore they must not be regarded as binding.

Front cover drawing is typical of the product range.

# PI734B



## WINDING 312

CONTROL SYSTEM	SEPARATELY EXCITED BY P.M.G.		
A.V.R.	MX341	MX321	
VOLTAGE REGULATION	± 1%	± 0.5 %	With 4% ENGINE GOVERNING
SUSTAINED SHORT CIRCUIT	REFER TO SHORT CIRCUIT DECREMENT CURVES (page 7)		

INSULATION SYSTEM	CLASS H
PROTECTION	IP23
RATED POWER FACTOR	0.8
STATOR WINDING	DOUBLE LAYER LAP
WINDING PITCH	TWO THIRDS
WINDING LEADS	6
MAIN STATOR RESISTANCE	0.0016 Ohms PER PHASE AT 22°C STAR CONNECTED
MAIN ROTOR RESISTANCE	1.67 Ohms at 22°C
EXCITER STATOR RESISTANCE	17.5 Ohms at 22°C
EXCITER ROTOR RESISTANCE	0.063 Ohms PER PHASE AT 22°C
R.F.I. SUPPRESSION	BS EN 61000-6-2 & BS EN 61000-6-4, VDE 0875G, VDE 0875N. refer to factory for others
WAVEFORM DISTORTION	NO LOAD < 1.5% NON-DISTORTING BALANCED LINEAR LOAD < 5.0%
MAXIMUM OVERSPEED	2250 Rev/Min
BEARING DRIVE END	BALL. 6228 C3
BEARING NON-DRIVE END	BALL. 6319 C3

	1 BEARING	2 BEARING
WEIGHT COMP. GENERATOR	2760 kg	2710 kg
WEIGHT WOUND STATOR	1306 kg	1306 kg
WEIGHT WOUND ROTOR	1139 kg	1077 kg
WR <sup>2</sup> INERTIA	32.7498 kgm <sup>2</sup>	31.7489 kgm <sup>2</sup>
SHIPPING WEIGHTS in a crate	2833kg	2779kg
PACKING CRATE SIZE	194 x 105 x 154(cm)	194 x 105 x 154(cm)

	50 Hz				60 Hz			
TELEPHONE INTERFERENCE	THF<2%				TIF<50			
COOLING AIR	2.69 m <sup>3</sup> /sec 5700 cfm				3.45 m <sup>3</sup> /sec 7300 cfm			
VOLTAGE STAR	380/220	400/231	415/240	440/254	416/240	440/254	460/266	480/277
KVA BASE RATING FOR REACTANCE VALUES	1360	1400	1400	1375	1525	1625	1655	1690
X <sub>d</sub> DIR. AXIS SYNCHRONOUS	3.50	3.26	3.02	2.64	4.25	4.04	3.77	3.53
X' <sub>d</sub> DIR. AXIS TRANSIENT	0.21	0.20	0.18	0.16	0.26	0.25	0.23	0.22
X'' <sub>d</sub> DIR. AXIS SUBTRANSIENT	0.16	0.15	0.14	0.12	0.19	0.18	0.17	0.16
X <sub>q</sub> QUAD. AXIS REACTANCE	2.26	2.10	1.95	1.70	2.74	2.61	2.43	2.28
X'' <sub>q</sub> QUAD. AXIS SUBTRANSIENT	0.32	0.29	0.27	0.24	0.38	0.37	0.34	0.32
X <sub>L</sub> LEAKAGE REACTANCE	0.04	0.04	0.03	0.03	0.05	0.05	0.04	0.04
X <sub>2</sub> NEGATIVE SEQUENCE	0.22	0.21	0.19	0.17	0.27	0.26	0.24	0.23
X <sub>0</sub> ZERO SEQUENCE	0.03	0.03	0.02	0.02	0.03	0.03	0.03	0.03

REACTANCES ARE SATURATED

VALUES ARE PER UNIT AT RATING AND VOLTAGE INDICATED

T' <sub>d</sub> TRANSIENT TIME CONST.	0.13s
T'' <sub>d</sub> SUB-TRANSTIME CONST.	0.01s
T' <sub>do</sub> O.C. FIELD TIME CONST.	2.14s
T <sub>a</sub> ARMATURE TIME CONST.	0.02s
SHORT CIRCUIT RATIO	1/X <sub>d</sub>

50  
Hz

PI734B  
Winding 312

**STAMFORD**

**THREE PHASE EFFICIENCY CURVES**

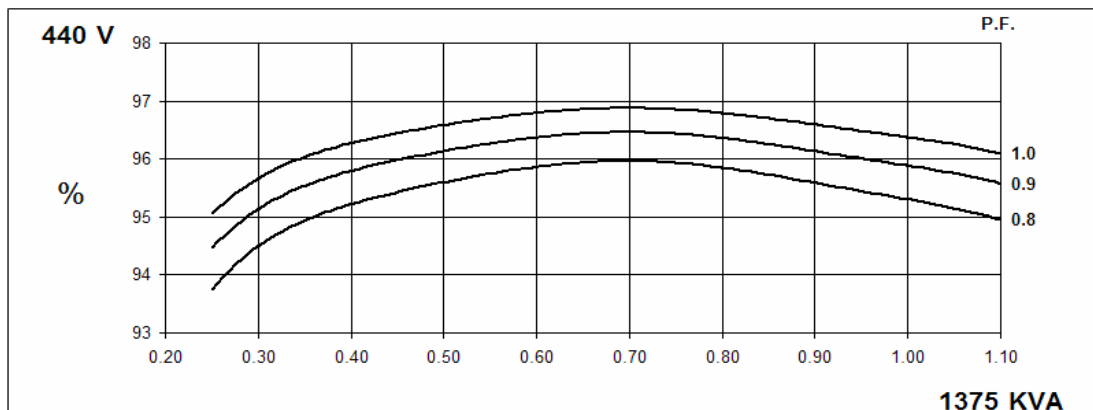
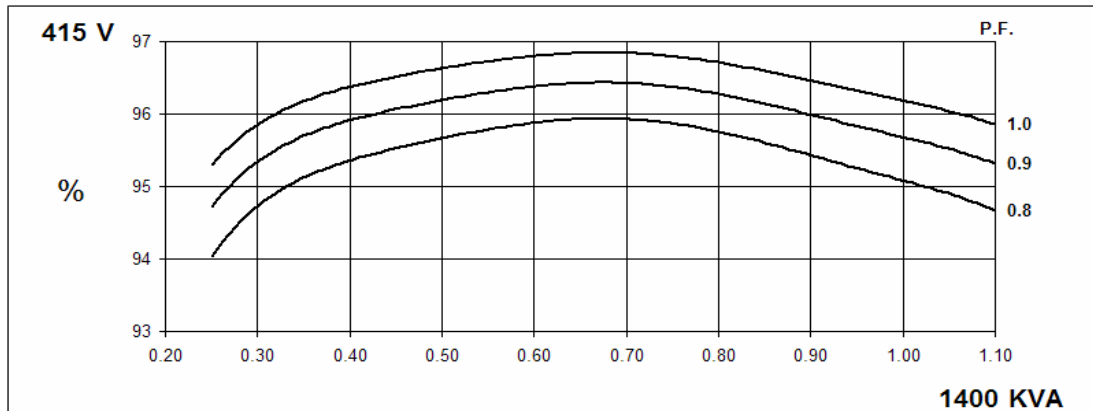
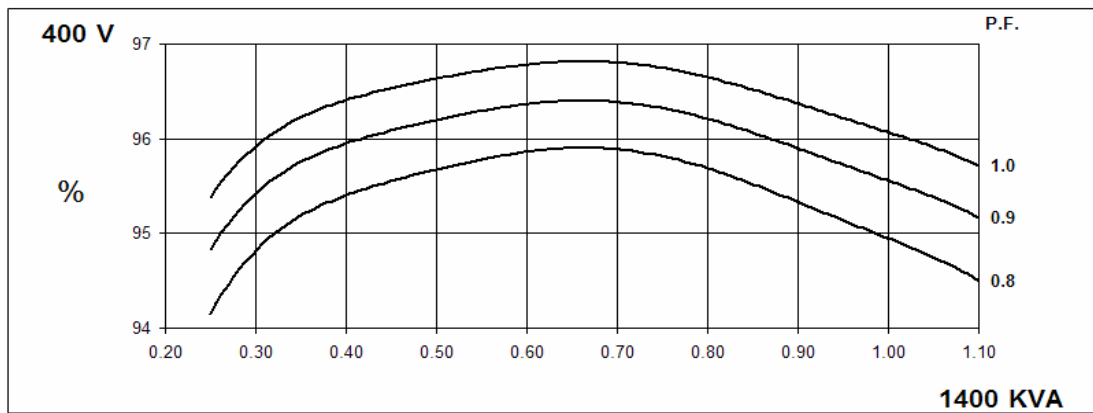
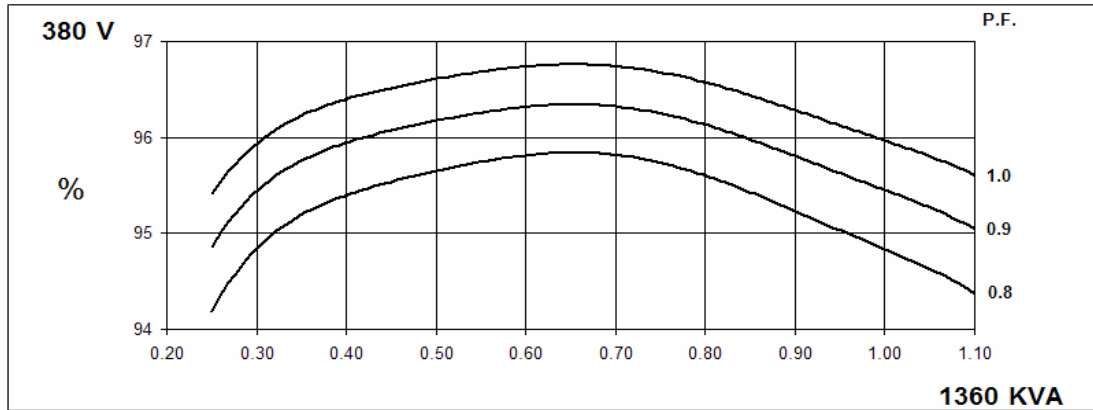

60  
Hz

PI734B  
Winding 312

STAMFORD

THREE PHASE EFFICIENCY CURVES

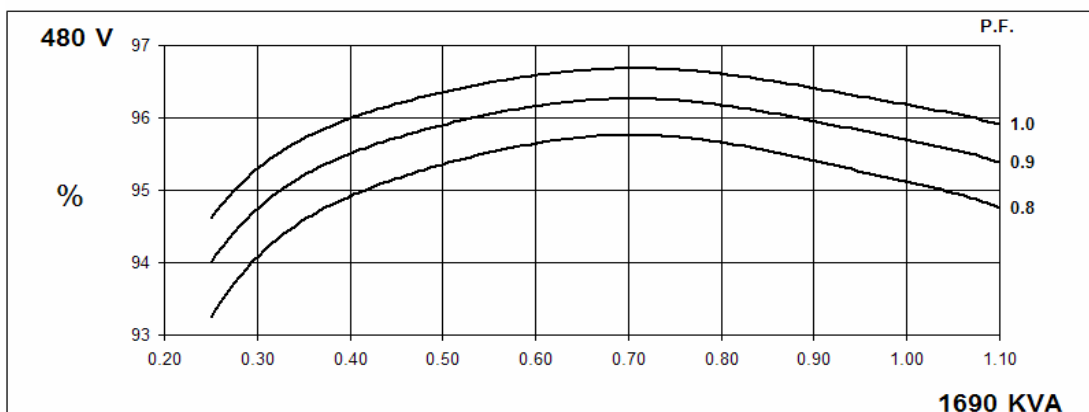
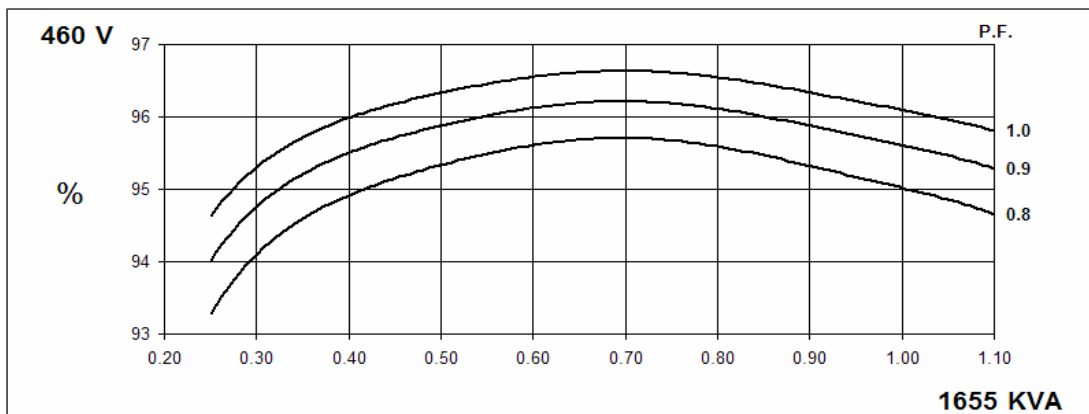
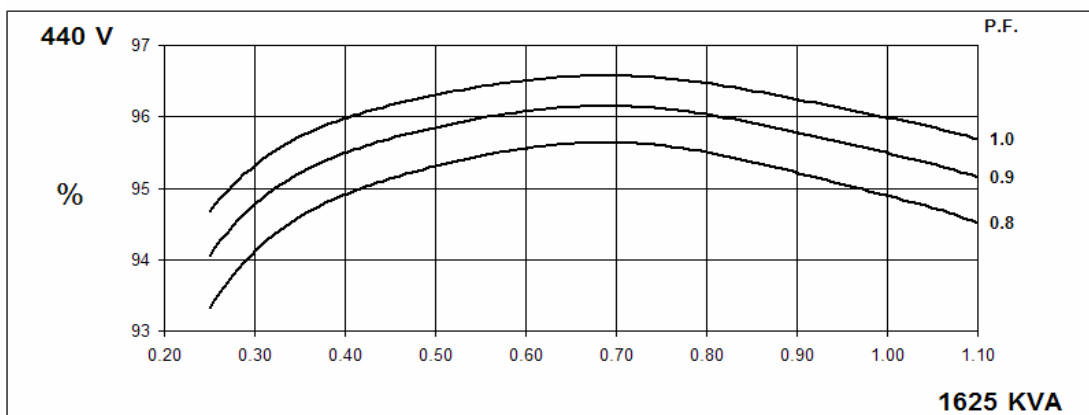
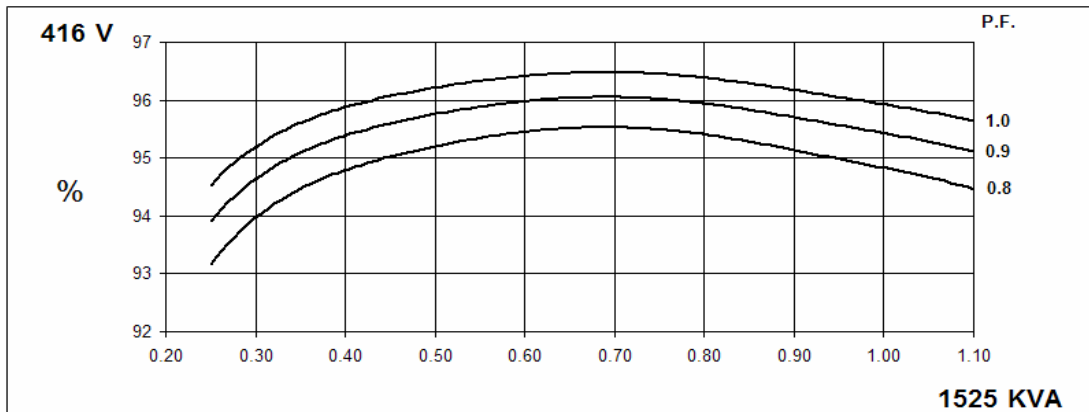

PI734B  
Winding 312

**STAMFORD**

**Locked Rotor Motor Starting Curve**

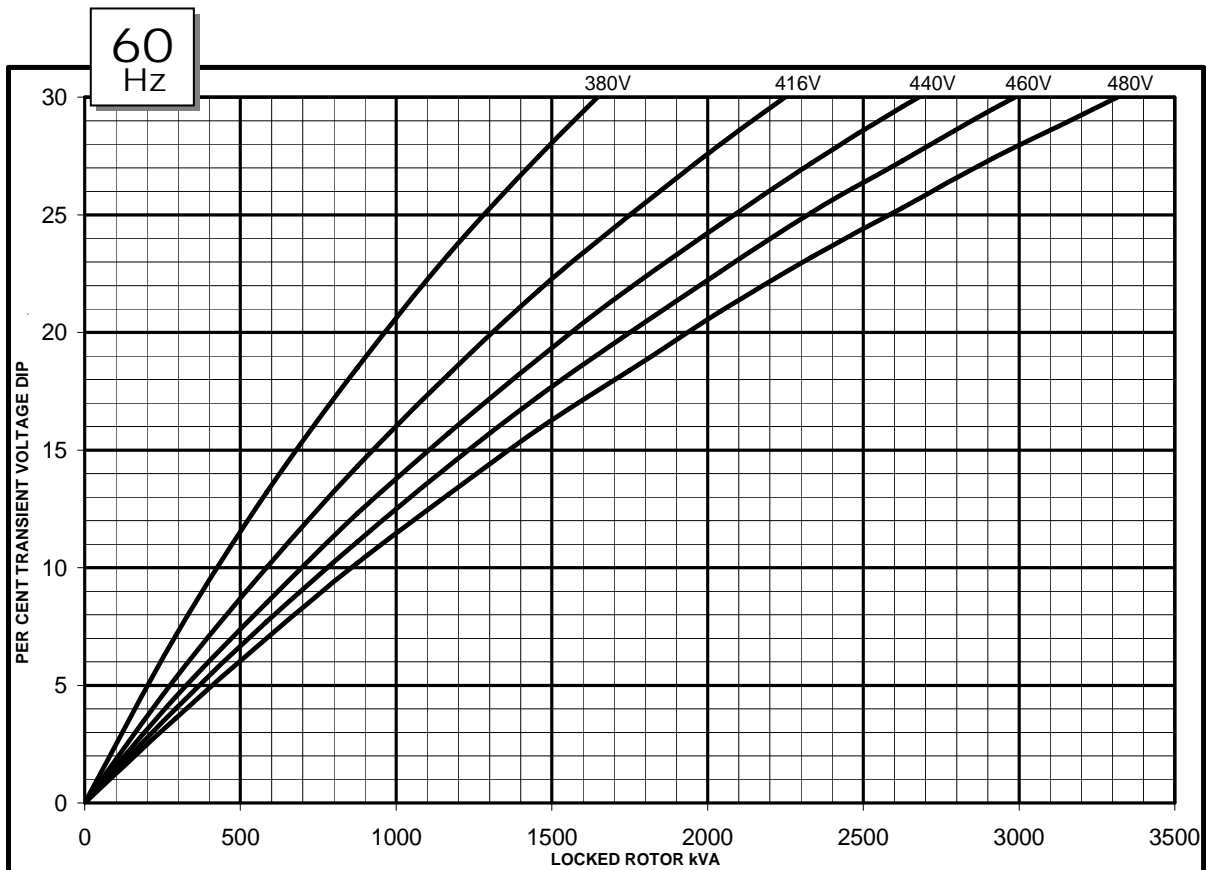
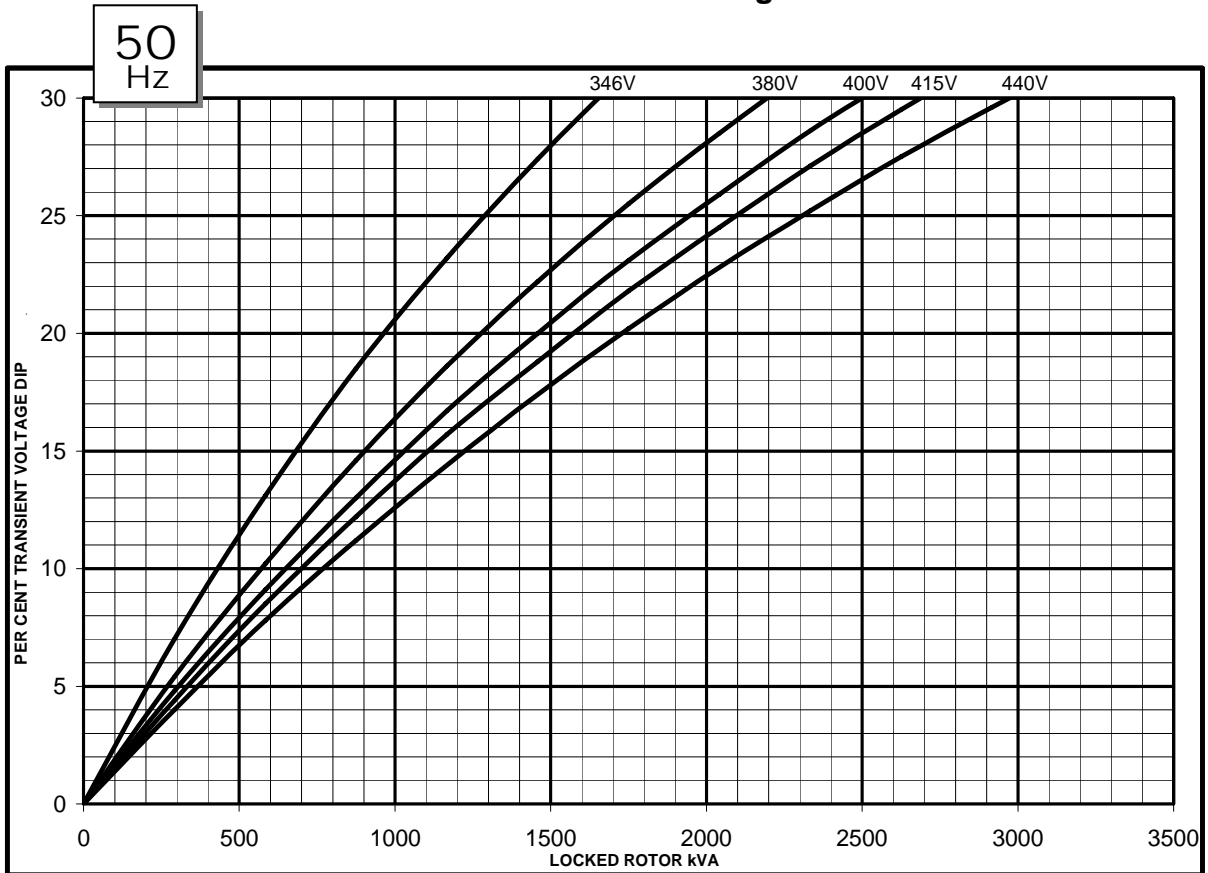



**Three-phase Short Circuit Decrement Curve. No-load Excitation at Rated Speed  
Based on star (wye) connection.**

**50  
Hz**

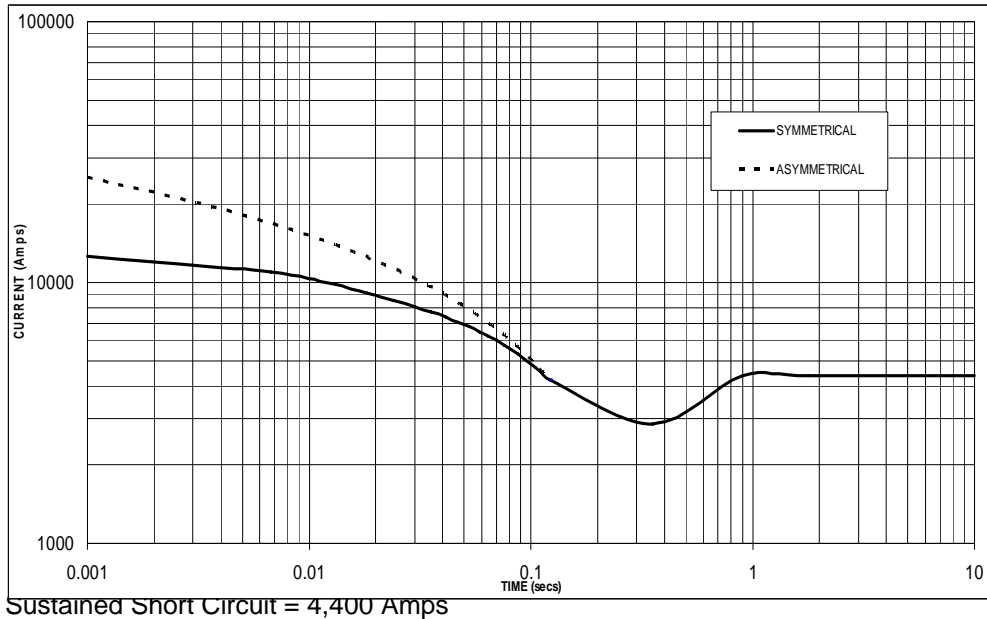

**60  
Hz**

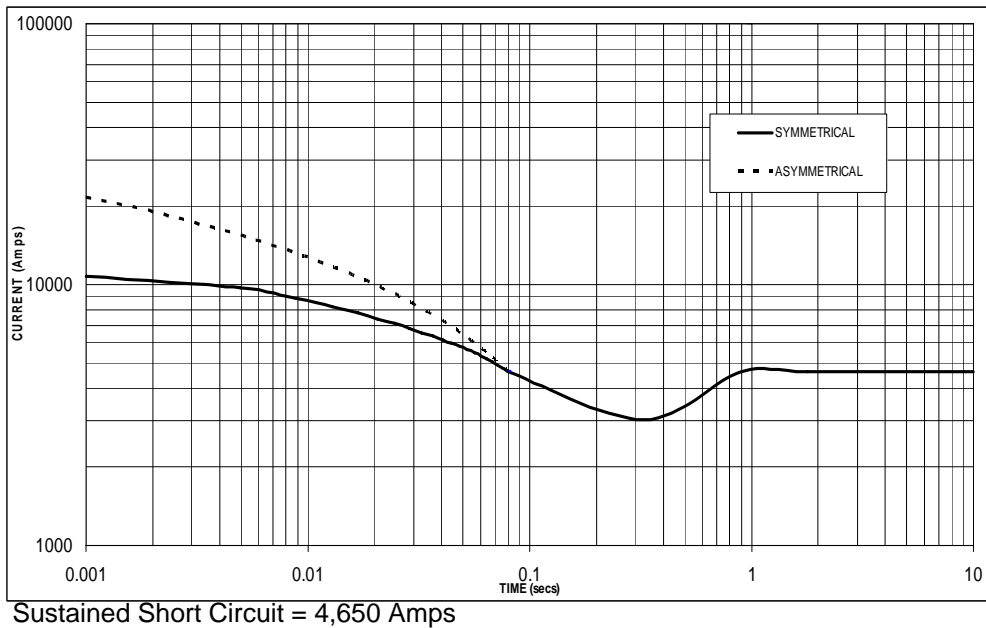

**Note 1**

The following multiplication factors should be used to adjust the values from curve between time 0.001 seconds and the minimum current point in respect of nominal operating voltage :

50Hz		60Hz	
Voltage	Factor	Voltage	Factor
380v	x 1.00	416v	x 1.00
400v	x 1.05	440v	x 1.06
415v	x 1.09	460v	x 1.10
440v	x 1.16	480v	x 1.15

The sustained current value is constant irrespective of voltage level

**Note 2**

The following multiplication factor should be used to convert the values calculated in accordance with NOTE 1 to those applicable to the various types of short circuit :

	3-phase	2-phase L-L	1-phase L-N
Instantaneous	x 1.00	x 0.87	x 1.30
Minimum	x 1.00	x 1.80	x 3.20
Sustained	x 1.00	x 1.50	x 2.50
Max. sustained duration	10 sec.	5 sec.	2 sec.

All other times are unchanged

**Note 3**

Curves are drawn for Star (Wye) connected machines.

**PI734B**  
**Winding 312 / 0.8 Power Factor**

**RATINGS**

Class - Temp Rise		Cont. F - 105/40°C				Cont. H - 125/40°C				Standby - 150/40°C				Standby - 163/27°C			
<b>50Hz</b>	Star (V)	380	400	415	440	380	400	415	440	380	400	415	440	380	400	415	440
	kVA	1265	1305	1305	1280	1360	1400	1400	1375	1415	1460	1460	1430	1455	1500	1500	1470
	kW	1012	1044	1044	1024	1088	1120	1120	1100	1132	1168	1168	1144	1164	1200	1200	1176
	Efficiency (%)	95.1	95.2	95.3	95.5	94.8	94.9	95.1	95.3	94.7	94.8	94.9	95.2	94.6	94.7	94.9	95.1
	kW Input	1064	1097	1095	1072	1148	1180	1178	1154	1195	1232	1231	1202	1230	1267	1264	1237

<b>60Hz</b>	Star (V)	416	440	460	480	416	440	460	480	416	440	460	480	416	440	460	480
	kVA	1415	1510	1540	1575	1525	1625	1655	1690	1590	1690	1725	1760	1630	1740	1775	1810
	kW	1132	1208	1232	1260	1220	1300	1324	1352	1272	1352	1380	1408	1304	1392	1420	1448
	Efficiency (%)	95.0	95.1	95.2	95.3	94.8	94.9	95.0	95.1	94.7	94.8	94.9	95.0	94.6	94.7	94.8	94.9
	kW Input	1192	1270	1294	1322	1287	1370	1394	1422	1343	1426	1454	1482	1378	1470	1498	1526

**DIMENSIONS**

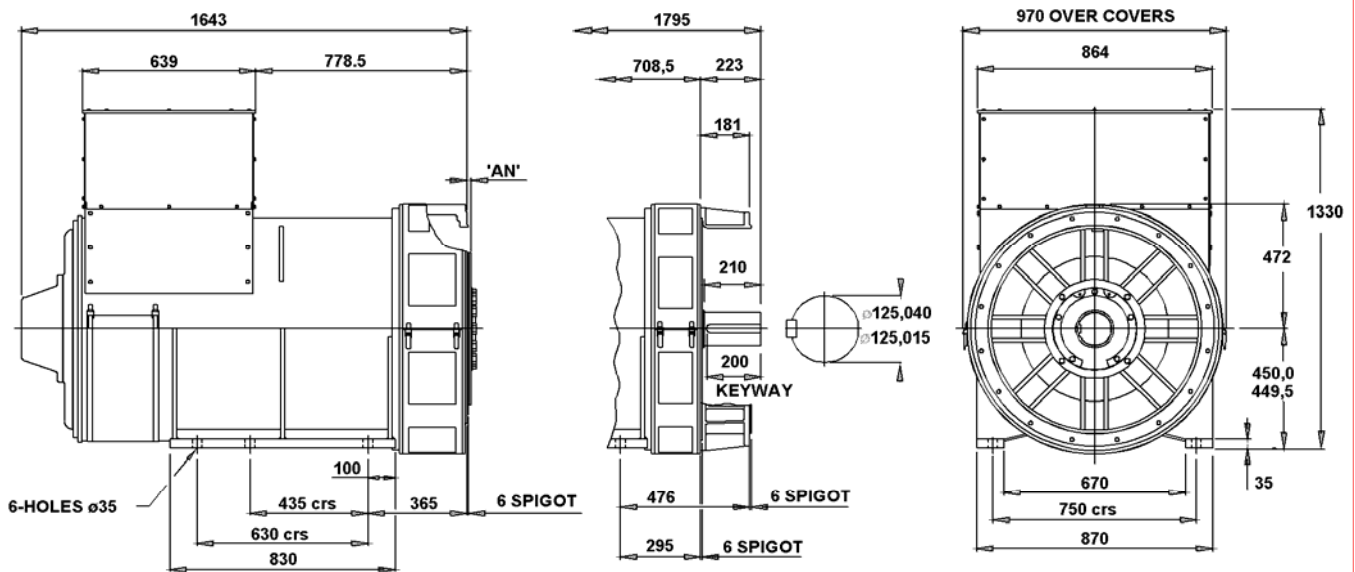

COUPLING DISC	'AN'
S.A.E No 18	15,7
S.A.E No 21	0
S.A.E No 24	0

1-BRG ADAPTORS
S.A.E No 0
S.A.E No 00

2-BRG ADAPTORS
S.A.E No 0
S.A.E No 00



UNITROL® 1000  
Compact and powerful  
Automatic voltage regulators

Power and productivity  
for a better world™



# Product benefits



**ABB is the world leading volume supplier of high quality UNITROL automatic voltage regulators (AVR) and static excitation systems (SES) that offers solutions for any type and size of power plant with high return on investment. UNITROL 1000 product family covers low power range applications and sets with respect to functionality, reliability and connectivity a new benchmark for the global industry.**

UNITROL 1000 provides compact and reliable solutions. Various built-in control software functions, robust mechanical and electrical design enable a wide range of applications.

## Main features

- Compact and robust AVR for excitation current up to 40 A
- Separate communication and control processors
- Wide range of built-in control software functions
- Ethernet-based fieldbus interface
- Wide range of power input voltage, for AC and DC input
- Flexible and freely configurable measurements and inputs/outputs (I/Os)

## Wide range of applications

- Land-based power plants based on diesel engines, gas or steam turbines and hydro turbines
- Marine: electrical propulsion and auxiliary supply
- Traction: diesel electric locomotives
- Wind: based on direct connected synchronous machines
- Synchronous motors

## Key benefits

### + Stable and reliable control of your machine

Highly integrated and robust AVR for harsh industrial environment. Stable and accurate regulation even with highly disturbed voltages.

### + AVR for various applications

Fully configurable I/Os and measurement inputs and user-specific configurable field bus interface enable easy plant integration.

### + Easy operation, monitoring and maintenance of the system

Intuitive and user-friendly commissioning tool.

### + Full support for grid codes

Built-in Power System Stabilizer (option), simulation models and grid code studies available.

### + Efficient product life cycle management

Extended life time of your assets with minimum costs.

### + Professional technical help always within your reach

ABB's global excitation service network.

# Portfolio

**UNITROL 1020 and UNITROL 1010 are the latest products of the UNITROL 1000 family. For most reliable operation, the communication and control tasks are split in separate controllers. The non-volatile flash memory of the AVR stores events and data logs to enable fault analysis and fast trouble shooting. Time synchronization is done over Ethernet communication, and the events and data logs are time-stamped.**

UNITROL 1000 is provided with modern communication ports like Ethernet and USB for connection of the PC-based commissioning tool CMT1000. Besides it is possible to power up the controller of the device via USB port. Thus the user can download files or configure the device even when no input power is available. AVR output stage is based on proven IGBT technology, which allows AC and/or DC voltage inputs from different sources.

UNITROL 1020 and UNITROL 1010 are designed for a wide range of ambient temperature and harsh environmental conditions and can be mounted directly on the machine.

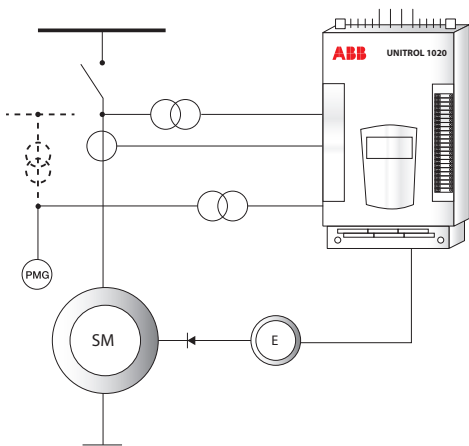
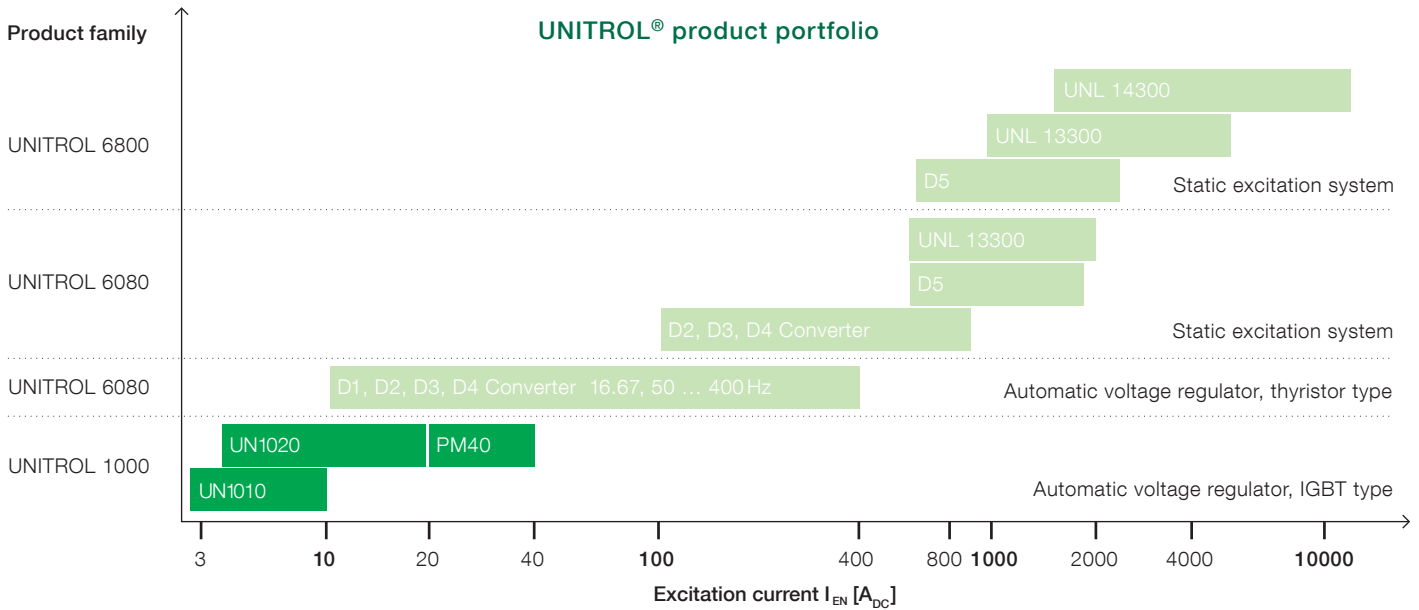

Single channel generator or motor excitation with PMG supply.

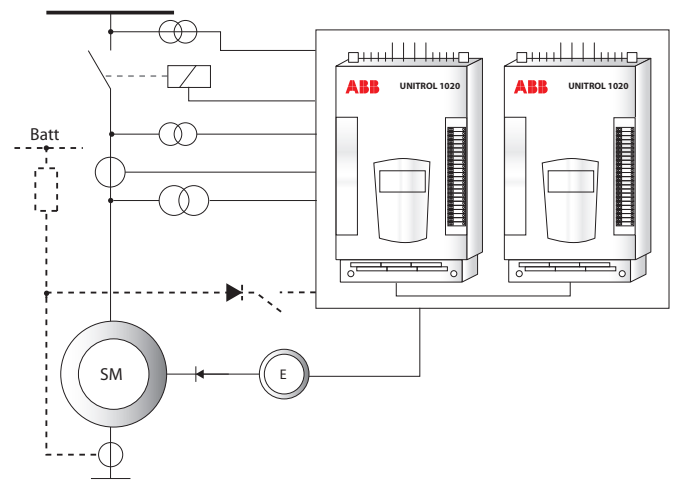

Dual channel generator or motor excitation with compounding and field flashing.

# Overview

UNITROL 1020 combines high performance control and power circuits with a simple mechanical design. The construction provides a platform for a broad range of small applications, including those in highly demanding

environmental conditions. Furthermore, high levels of EMC immunity is achieved through separation of the power and measurement terminals from the I/O connectors.

## Polymer housing

Protects all live parts to prevent electric shocks.

## USB port

- Connects the CMT1000 (commissioning and maintenance tool)
- Device configuration and event and data upload without any other power supply

## Indication LEDs

- Green: Power ON, blinking indicates software is running
- Yellow: Excitation ON, blinking indicates limiter is active
- Red: Alarm, blinking indicates start up error

## Ethernet port

- Connects the CMT1000
- Remote access over Modbus TCP

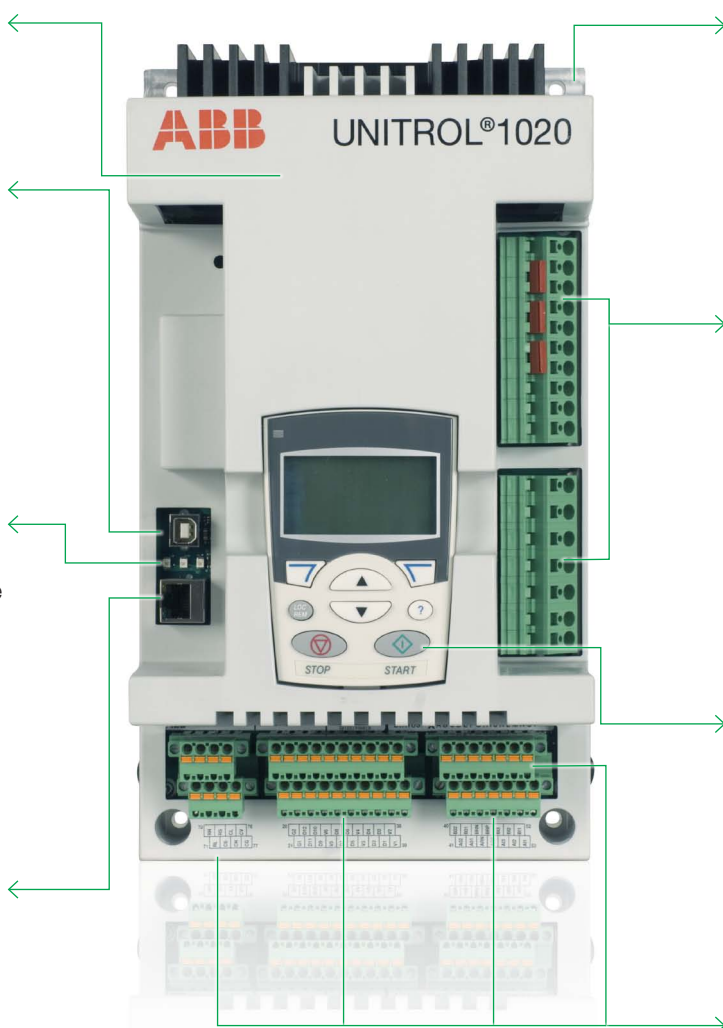

## Solid aluminium base plate

- Robust mechanical design allows use in high vibration applications.
- Can be mounted directly within the machine terminal box.

## Power and measurement terminals

- Specified up to 30 A continuous current and max. cable up to 4 mm<sup>2</sup> (AWG 24–10)
- Tension spring terminals for reliable connection
- Easy access over test points

## Local human interface

- Intuitive local control panel for indication of AVR status, active limiters and measurements
- Local control can be taken over to change parameters

## Analog and digital inputs and outputs, serial fieldbus

Tension spring connectors allow reliable wiring and fast replacement.

Local human-machine interface provides immediate data on AVR status.

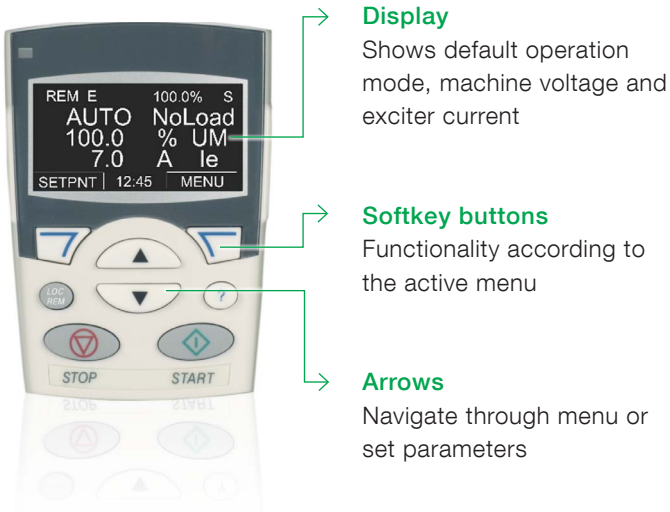

**Display**

Shows default operation mode, machine voltage and exciter current

**Softkey buttons**

Functionality according to the active menu

**Arrows**

Navigate through menu or set parameters

The UNITROL 1000 family has freely configurable measurement and analog or digital I/Os. The configuration is done via the local human-machine interface or CMT1000 software.

**Power terminals**

- 3 phase excitation power input
- 3 phase auxiliary power input (control power supply)
- Excitation output

**Measurement terminals**

- 3 phase machine voltage
- 1 phase network voltage
- 1 phase machine current

**Analog I/O**

- 2 outputs / 3 inputs (configurable)
- +10V / -10V references output

**Digital I/O**

- 4 inputs only (configurable)
- 8 inputs / outputs (configurable)
- 24 V output (600 mA) for external relay

**Serial fieldbus**

- RS485 for Modbus RTU or VDC communication
- CAN for dual channel communication

UNITROL 1010 is a compact device with limited functionality and is designed for excitation currents up to 10A nominal. It supports the same interfaces and has the same mechanical footprint as UNITROL 1020.



UNITROL 1000-PM40 is the power module that extends the output current of the UNITROL 1020 up to 40 A.



# Control software

The UNITROL 1000's software has all the functions necessary for modern excitation systems. ABB offers three software-function packages out of the shelf.

## LIGHT

The **LIGHT** version covers essential functionality for cost sensitive applications where limited software functionality is required.

- Regulator control modes: Bumpless transfer between all modes
  - Automatic voltage regulator (AVR)
  - Field current regulator (FCR)
  - Power factor regulator (PF)
  - Reactive power regulator (VAR)
- Limiters: Keeping synchronous machines in a safe and stable operation area
  - Excitation current limiter (min. / max.)
  - PQ minimum limiter
  - Machine current limiter
  - V / Hz limiter
  - Machine voltage limiter
- Voltage matching

## BASIC

The **BASIC** version covers all functionality of **LIGHT** in addition to the following:

- Modbus TCP
- Rotating diode monitoring
- VDC mode: Reactive load sharing for up to 31 machines in island operation.
- Dual channel / monitoring: Enables the dual channel operation based on self diagnostics and setpoint follow up over CAN communication.

## Available software packages:

	Software function	UNITROL 1010		UNITROL 1020	
<b>LIGHT</b>	AVR / FCR / PF / VAR	LIGHT	BASIC	BASIC + SYNCHRONIZATION	BASIC
	Limiters				
	Voltage matching				
<b>BASIC</b> (Configurable SW)	Modbus TCP	BASIC	BASIC + SYNCHRONIZATION	BASIC + SYNCHRONIZATION	FULL
	Rotating diode monitoring				
	VDC mode				
	Dual channel / monitoring				
<b>FULL</b> (Configurable SW)	Synchronization	FULL	FULL + PSS	FULL + PSS	FULL + PSS
	Event logger				
	Data logger				
	Real-time clock				
<b>OPTION</b>	Power system stabilizer (PSS)				

## FULL

The **FULL** version covers all functionality of **BASIC** in addition to the following:

- Synchronization: Fast and reliable built-in synchronizer.
- Event logger: Up to 500 events are stored in a non-volatile memory.
- Data logger: A data log of 12 signals is saved automatically in the non-volatile memory.
- Real-time clock: For accurate time stamped events and data logs.

## Power system stabilizer (PSS)

The **FULL** software version can be complemented with the power system stabilizer function. Compliant with the standard IEEE 421.5-2005 2A/2B, the PSS improves the stability of the generator over the highest possible operation range.



# Commissioning and maintenance tool CMT1000

CMT1000 is a commissioning and maintenance tool for the UNITROL 1000 product family. The tool is used to setup all parameters and tune the PID to guarantee stable operation. The CMT1000 software allows an extensive supervision of the system, which helps the user to identify and locate problems during on-site commissioning.

The CMT1000 is connected to the UNITROL 1000 via USB or Ethernet port, where Ethernet connection allows remote access over 100 meters.

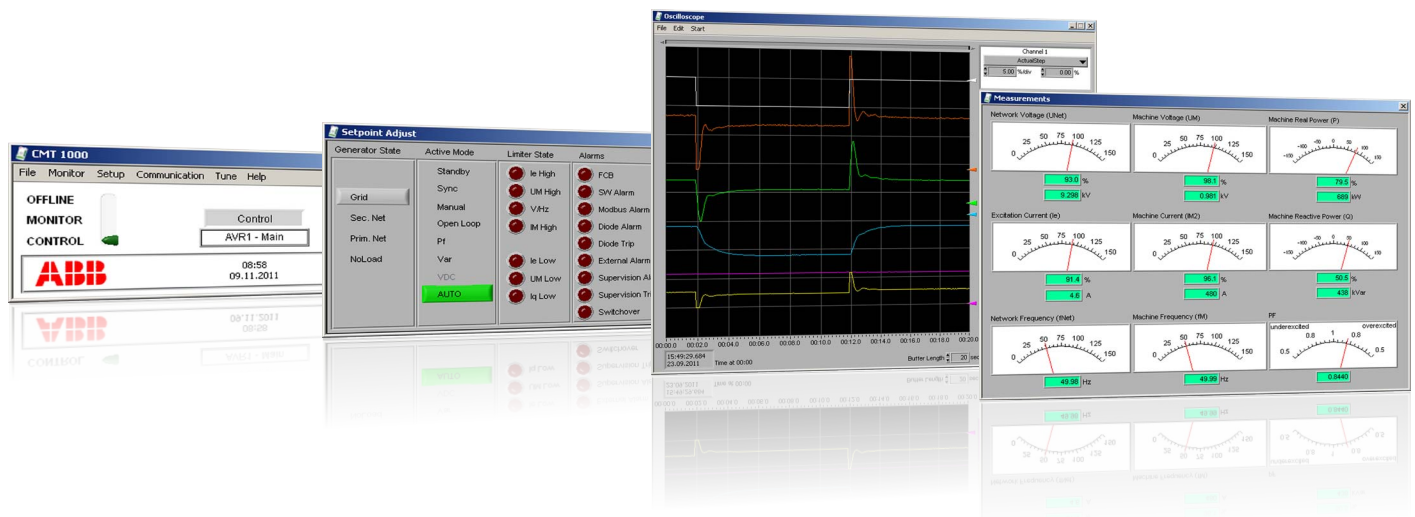

## Main window

- Indication of access mode and device information.
- Change of parameter is only possible in CONTROL access mode.
- LED symbol indicates that all parameters are stored on non-volatile memory.

## Setpoint adjust window

- Overview of all control modes, alarms, generator and active limiters status.
- Set point adjustment and application of steps for tuning of the PID.

## Oscilloscope

- 6 signals can be selected out of 20 recorded channels.
- The time resolution is 50 ms.
- Files can be saved to PC for further investigation.

## Measurement

- All measurements on one screen.

# Technical data and order codes

## UNITROL 1010/UNITROL 1020

### Power electronic input

AC input voltage 3-phase (max., sinusoidal)	0 to 300 V <sub>AC</sub>
DC input voltage (max.)	0 to 300 V <sub>DC</sub>
Max. peak input voltage (not sinusoidal)	420 V <sub>p</sub>

### Voltage regulation

Accuracy at 25 °C	0.1 %
AVR response time (3-phase meas.)	< 20 ms
AVR response time (1-phase meas.)	< 50 ms
PWM limitation	0.5 to 99 %

### Excitation output UNITROL 1020

Continuous output current (40 °C) (55 °C requires an external capacitor)	20 A <sub>DC</sub>
Continuous output current (55 °C)	15 A <sub>DC</sub>
Overload current for 10 sec. (55 °C)	40 A <sub>DC</sub>

### Excitation output UNITROL 1010

Continuous output current (55 °C)	10 A <sub>DC</sub>
Overload current for 10 sec. (55 °C)	20 A <sub>DC</sub>

### Auxiliary supply (controller) input

AC input voltage 3-phase (max., sinusoidal)	9 to 300 V <sub>AC</sub>
AC input voltage 1-phase (max., sinusoidal)	16 to 300 V <sub>AC</sub>
DC input voltage (max.)	18 to 300 V <sub>DC</sub>
Max. peak input voltage (not sinusoidal)	400 V <sub>p</sub>

### Exciter current measurements

Full range	0 to 40 A
Accuracy	< 1 %
Resolution	< 100 mA

### Measurements

Machine voltage, 1, 2 or 3 phase	up to 500 V <sub>AC</sub>
Machine current, 1 phase	1 to 5 A <sub>AX</sub>
Network voltage, 1 phase	up to 500 V <sub>AC</sub>
Frequency range	10 to 150 Hz
Accuracy	< ± 1 %

### 24 V digital I/O, 4 inputs, 8 I/Os

Digital input impedance	< 2 kΩ
Digital input threshold (low / high)	5 V / 13 V
Digital output, max. output current	150 mA

### ±10V analog I/O, 3 inputs, 2 outputs

Analog inputs impedance	< 240 kΩ
Analog output impedance	100 Ω

### Communication interfaces

Ethernet (cable length < 100 m)	10 / 100 MBit/s
USB version (cable length < 3 m)	1.0; 1.1; 2.0
RS485 data rate (cable length < 500 m)	Configurable
CAN (cable length < 3 m)	Only for connections between UNITROL 1000 devices (UNITROL 1000-PM40 or dual channel configuration)

### Environmental data

Permissible ambient temperature	-40 to 70 °C
Maximum heat sink temperature	90 °C

### Mechanical stability

Vibration, IEC 60068-2-6	DNV class B
Shock and bump, IEC 60255-21-2	Class 2
Seismic, IEC 60255-21-3	Class 2

### EMC standards

Generic immunity standard EN 61000-6-2	
Generic emission standard IEC 61000-6-4	

### Certifications

CE certification	
cUL certifications according UL 508c (compliant with CSA)	
DNV certification according class B	

## UNITROL 1000-PM40

### Power electronic input

AC input voltage 3-phase (max.)	0 to 250 V <sub>AC</sub>
DC input voltage (max.)	0 to 300 V <sub>DC</sub>
Absolute max. peak input voltage	350 V <sub>p</sub>

### Excitation output UNITROL 1000-PM40

Continuous output current (55 °C)	40 A <sub>DC</sub>
Overload current for 10 sec. (55 °C)	80 A

## Order codes

### UNITROL 1010

UNITROL 1010-0002 LIGHT	3BHE035301R0002
UNITROL 1010-0003 BASIC	3BHE035301R0003
UNITROL 1010-0004 BASIC + SYNC	3BHE035301R0004

### UNITROL 1020

UNITROL 1020-0003 BASIC	3BHE030579R0003
UNITROL 1020-0004 BASIC + SYNC	3BHE030579R0004
UNITROL 1020-0006 FULL	3BHE030579R0006
UNITROL 1020-0007 FULL + PSS	3BHE030579R0007

### UNITROL 1000-PM40

UNITROL 1000-PM40	3BHE015411R0001
-------------------	-----------------

Devices are shipped with a CD containing a CMT1000 commissioning and maintenance tool, a production test certificate and manuals.

# Mechanical dimensions

## UNITROL 1020

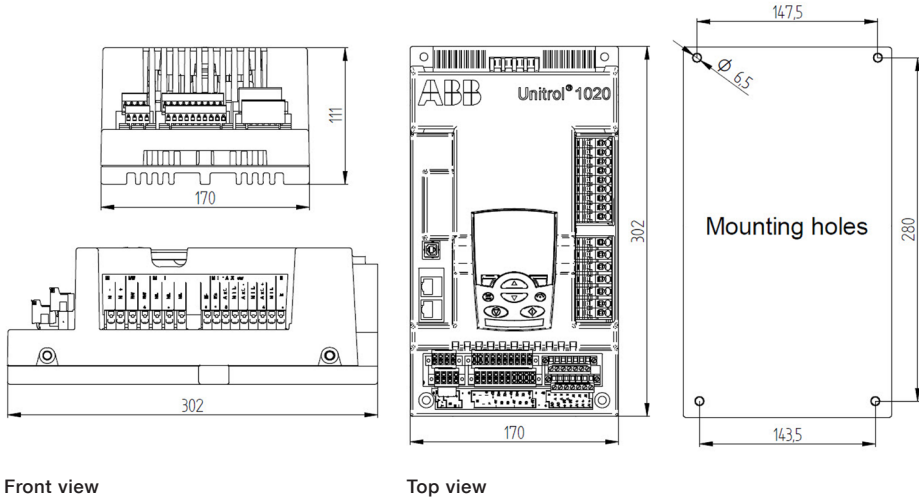

Front view

Top view

## UNITROL 1010

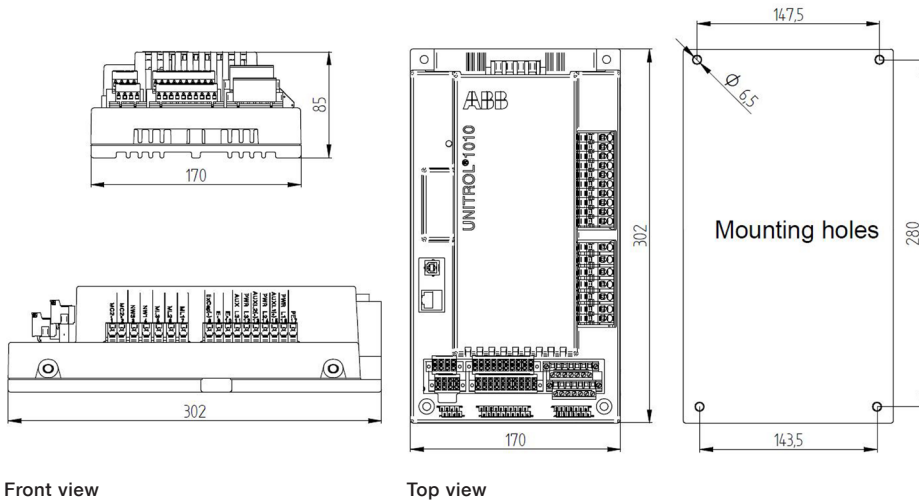

Front view

Top view

## UNITROL 1000-PM40

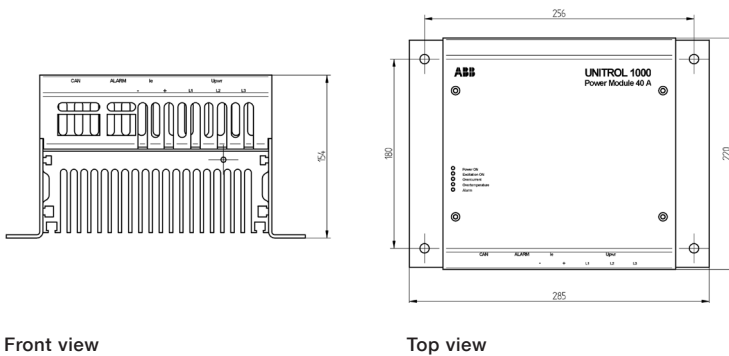

Front view

Top view

# Grid codes and UNITROL 1000 systems

## Grid codes

Built-in power system stabilizer and fast detection of voltage dips are prerequisites to meet any grid codes.

ABB provides detailed computer representation of internal control algorithm and IEEE models for system simulations.

In addition, ABB provides several levels of service:

- Calculation of PSS parameter
- Simulations of reference step responses
- Stability simulations for various different network conditions

ABB provides detailed questionnaires and provides results in a report.

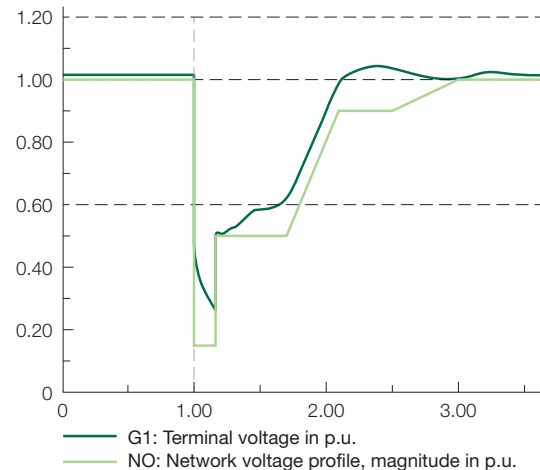

Example of fault ride through defined grid code. ABB offers grid code compliant studies in order to prove stability under all circumstances.

## UNITROL 1000 systems

ABB provides over 100 years of experience in building project specific engineered systems for any applications.

ABB offers various different systems depending on the need of the customer:

- Single channel systems
- Dual channel systems
- Mounting on a plate or in a cubicle

Systems include protection breaker and exciter field breaker. They are fully tested in the ABB factory and AVR setting can be ordered preset.

Ask our expert for more information about:

- Variable speed applications
- Multiple power input sources
- Synchronization of your machine
- I/O extension with external programmable logic controller over field bus



3D model of dual-channel system on a mounting plate.

# Service and support

**For life cycle management or technical support, the worldwide network of UNITROL specialists is at your service.**

## **Installation and commissioning**

The professionalism, extensive experience and multilingual skills of ABB's engineers ensure a satisfactory installation and commissioning.

## **Training**

ABB university offers standard and customized training courses for UNITROL excitation systems. On-site training options are also available. For a detailed training program, visit [www.abb.com/abbuniversity](http://www.abb.com/abbuniversity)

## **e-Learning**

With the UNITROL 1000 interactive e-learning program you decide where and when you learn. The program covers general excitation knowledge as well as detailed product handling know-how.

## **UNITROL 1000 global support organization**

A team of qualified engineers located in different ABB organizations worldwide are ready to support you with your most challenging enquiries and application requirements.

## **Life cycle management**

ABB's excitation systems life cycle management model helps the customers to extend and maximize the life cycle of their assets at minimum costs. Depending on the product's life cycle phase, the service specialists recommend necessary actions and approach the clients pro-actively to inform them on all maintenance, service and upgrade necessities.

## **Examples of life cycle services:**

- Technical support for optimized reliability
- Spare parts delivery
- Preventive and corrective maintenance
- Upgrade and modernization

**For urgent technical assistance, please call the hotline:**

**+41 (0)844 845 845**

**(365 days / 24 hours)**

**or contact ABB by e-mail:**

**[unitrol1000support@ch.abb.com](mailto:unitrol1000support@ch.abb.com)**



# Contact us

**ABB Switzerland Ltd**  
**Static Excitation Systems, Voltage**  
**Regulators and Synchronizing Equipment**  
CH-5300 Turgi, Switzerland  
Phone: +41 (0)58 589 24 86  
Fax: +41 (0)58 589 23 33  
E-Mail: [pes@ch.abb.com](mailto:pes@ch.abb.com)

[www.abb.com/unitrol](http://www.abb.com/unitrol)

© Copyright ABB. All rights reserved.  
Specifications subject to change without  
notice.

3BHS353843 E01 Rev. A | Printed in Switzerland, 2012